

# 四方A枠面格子 使用部材・部品

型 材			
 <p>A 枠 (定尺 L=5500)</p>	 <p>クロス格子・ 井桁格子用格子 (定尺 L=5500)</p>	 <p>四方A枠たて面格子・ 四方A枠横面格子用格子 (定尺 L=6000)</p>	 <p>補強FB-2x15 (定尺 L=4000)</p>
 <p>特殊格子 18角格子 (U・TW・K・D・B) (定尺 L=5600)</p>	 <p>特殊格子 30×20格子 (U・K・D・B) (定尺 L=6000)</p>	 <p>ポール用裏板 ポール (U・K・D・B) (定尺 L=6000)</p>	
ブラケット類			
 <p>カチコミブラケット54 (住宅用・ビル用兼用) 面格子W=レール内法W+5</p>	 <p>標準ブラケット</p>	 <p>入隅ブラケット</p>	 <p>各種ブラケット用型材</p>
 <p>すっきりAブラケット 面格子W=サツ枠外々寸法+26</p>	 <p>すっきりBブラケット 面格子W=サツ枠外々寸法+72</p>	 <p>すっきりCブラケット 面格子W=サツ枠外々寸法+26</p>	

# 四方A枠面格子 標準納まり図

標準ブラケット壁付け納まり

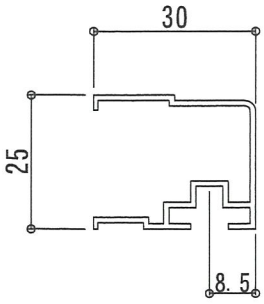
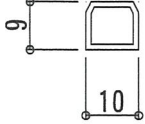
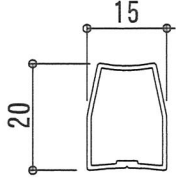
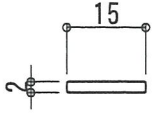
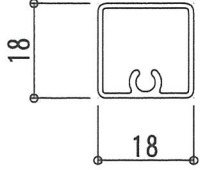
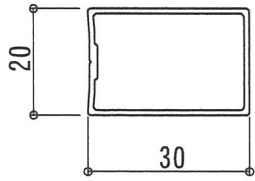
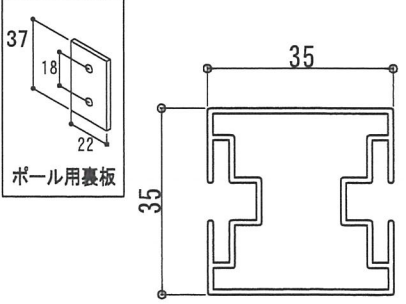
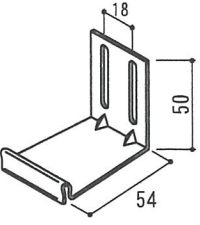
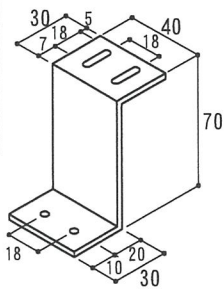
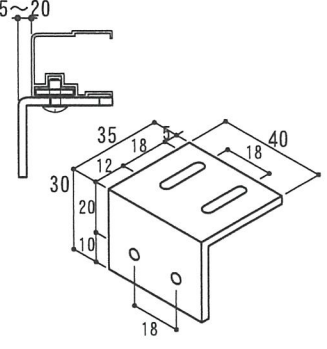
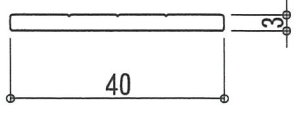
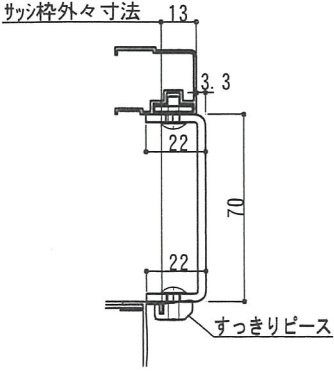
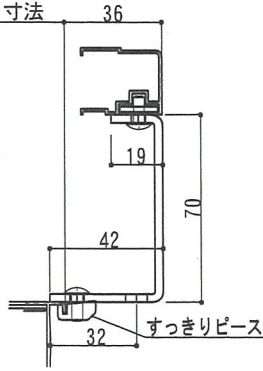
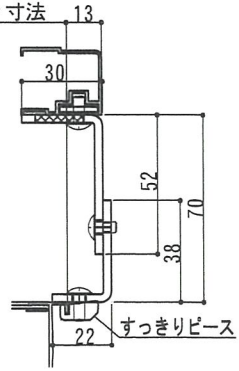
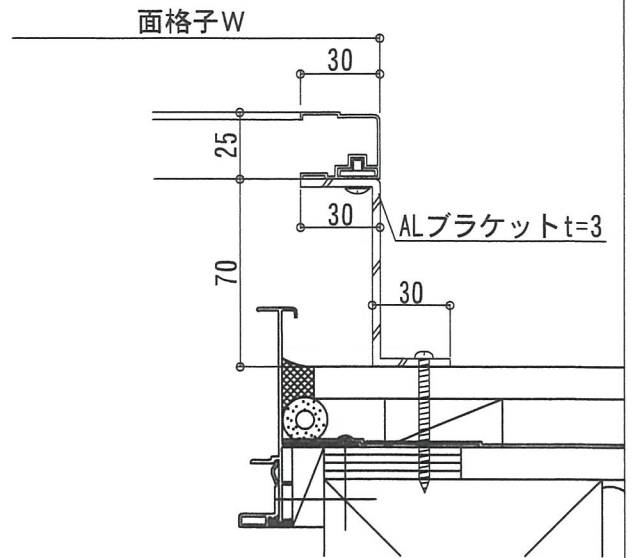
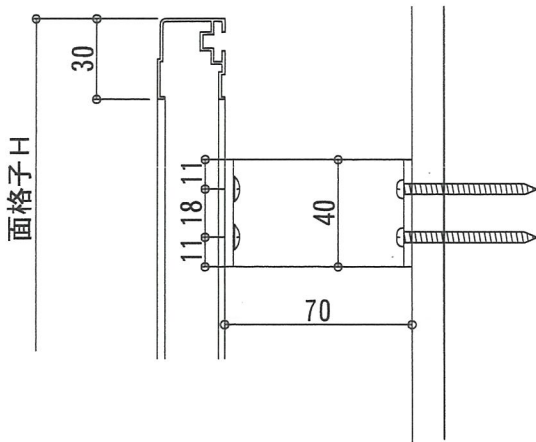

カチコミブラケット54納まり

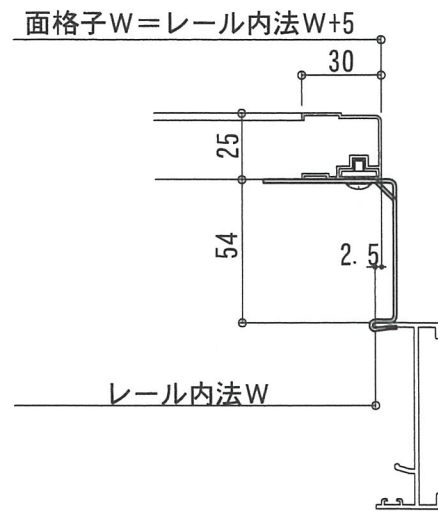
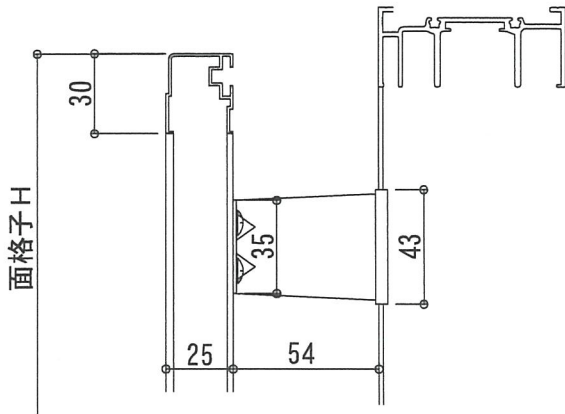

ポール使用壁付け納まり

